

Cooling Systems

Bürkert Fluid Control Systems
Christian-Bürkert-Straße 13-17
74653 Ingelfingen
Germany

Tel. +49 (0) 7940/10-0
Fax +49 (0) 7940/10-204

info@burkert.com
www.burkert.com



bürkert
FLUID CONTROL SYSTEMS

Content

- 5 _____ Company Profile
- 6 _____ Products and Systems
- 9 _____ Plastic Injection
- 12 _____ Die Casting
- 15 _____ Induction Heating
- 16 _____ Welding
- 20 _____ Cooling Utilities
- 23 _____ Thermoforming
- 24 _____ Extrusion
- 27 _____ Machining
- 30 _____ Contacts



Cooling Systems.

Our focus on cooling derives from the commitment to our customers to work with the physical attributes of the application environments of your world. In this overview you will find examples which allow you to examine some of our core process competencies.

We believe we have intimate knowledge and significant insight into the application environments that traverse the broad spectrum of cooling. We can collaborate with you in the real physics of molding, cutting, welding, quenching and heat exchange, where we can share our experience in complete control loops for flow, pressure and, of course, temperature.

We can assist you in determining the most effective cooling architecture to help you see and assess what is happening in your plant from the control room or the board room. Every member of our company listens to you with the aim of fluently presenting you with only the most appropriate solution in your daily application language. The inherent expertise we offer at Bürkert exists to make your life simpler.

Our versatile systems highlight our continuous customer oriented innovation and are developed to uncomplicate any cooling situation, which in turn will save you time. An otherwise unattainable synergy of hardworking valve elements, process actuation, sensors and networked communication provide a true single source of remarkably attractive systems, peace of mind, process safety and joy of use.

In a world where compactness, reliability and quality are paramount, Bürkert offers you unlimited and extremely cool modularity.

Welcome to the Fascinating World of Fluid Control Systems.

Measurement and control: When it comes to working with fluids and gases, we are at your side—as a manufacturer of sophisticated products, as a problem-solver with an eye for the big picture, and as a partner offering you reliable advice. Since we started in 1946, we have developed into one of the world's leading suppliers of Fluid Control Systems. At the same time we have kept our status as a family-run business with a foundation of strong basic values to highlight the way we think and act.

What we build on: Experience

We bring together over 60 years of applied knowledge, theoretical expertise and all-round experience in the field of Fluid Control Systems. We at Bürkert have always taken care to ensure that the insights gained in working on innumerable products and projects are passed on, not only among our over 1,900 employees in various locations and divisions, but also from one Bürkert generation to the next. We focus all our curiosity, passion and commitment on one goal: to provide solutions that take your company that essential step forward.

What sets us apart: Closeness

To engineer expert solutions with added value, you need to be close to your customers and their problems—as we are. For us at Bürkert, closeness means personal closeness. We listen to your every word and do everything in our power to devise and implement the best solution for your needs. Closeness also applies in a technical sense. We know exactly what role our products play in your complex processes. Last but not least, we understand closeness in a geographical sense: Our global presence with over 35 branches and seven production sites allows our customers to draw on technological innovations from all over the world.

What drives us forward: Courage

We aim to surpass your expectations. To make it happen, one quality is vital: courage. The courage not just to look forward but to move forward, to challenge conventional wisdom, to do things differently, to tackle problems others think are impossible and to never give up when the going gets tough. We demonstrate this courage time and again. Our wealth of experience is the solid platform on which our courage is based. It allows us to turn courage into creativity, convert off-beat ideas into surprising innovations and put together individual components to create completely new systems that open up unexpected possibilities.



Good from Every Angle: Our Products.

You can see Bürkert as a supplier who simply provides you with good products. We are happy to fill that role—but what really makes us proud is when you see us as a partner who joins you in getting the job done—however complex. Even if the problem seems irresolvable, challenge us. Put our courage to the test: It's the tough challenges that drive us, moving you and us forward.

Whether with an individual component or a groundbreaking new system for the entire process of measurement and control, we are at your side at all times with a seamless range of services, from consulting and engineering, to installation, testing and after-sales service.

We work with engineering consultants, integrators, contractors, original equipment manufacturers, and end users in a spectrum of industries from automotive parts hardening to pharmaceutical product packaging. We offer expertise in optimized system solutions for injection molding, die casting, induction hardening, welding, industrial cooling, thermoforming, extrusion equipment, and machining ... in your application language. Speaking a common language eases communication and lays the foundation for your success.

Innovative, Value-added Solutions Combine the Best of All Worlds.

Fluids are fascinating media. And it is this very fascination with liquids and gases that drives us to develop ever new devices that can handle them even better. We are one of the few suppliers on the market to cover the complete control loop. Our current product range extends from solenoid valves through process and analytical valves to pneumatic actuators and sensors.

To meet our customers' ever-increasing demands, the people at our four research and development centers constantly work on improving both our individual products and our range as a whole. Products that solve a particular problem perfectly, that offer a true value-added benefit over other products, and that meet specific industry requirements.

In the cooling process arena, we have worked continuously to guide the latest specifications, requirements, and to be involved with special interest groups that push the industry towards higher standards and improved value for their customers. We believe we have done the work that allows you to conduct your business with peace of mind. When you specify Bürkert you know you will receive real, traceable, and consistent quality ... quickly.

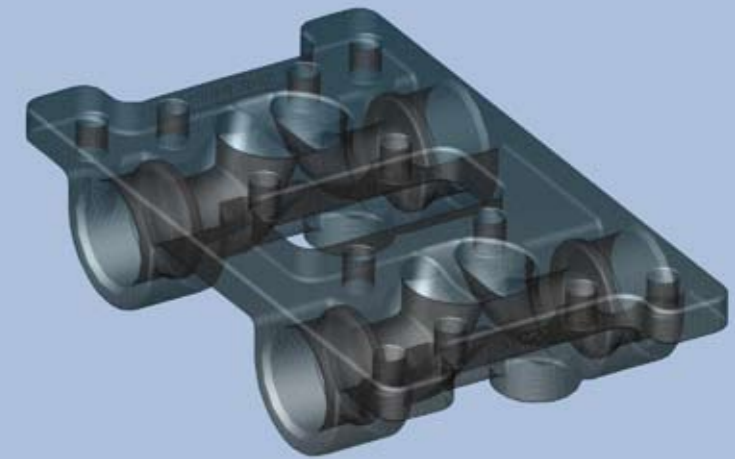
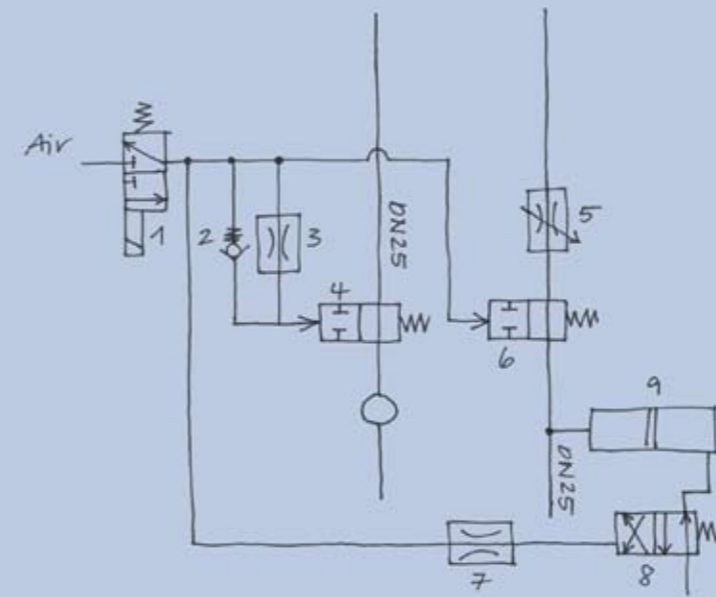

IDEAS & CONSULTING

SIMULATION & DEVELOPMENT

SYSTEM DEVELOPMENT

PROTOTYPE



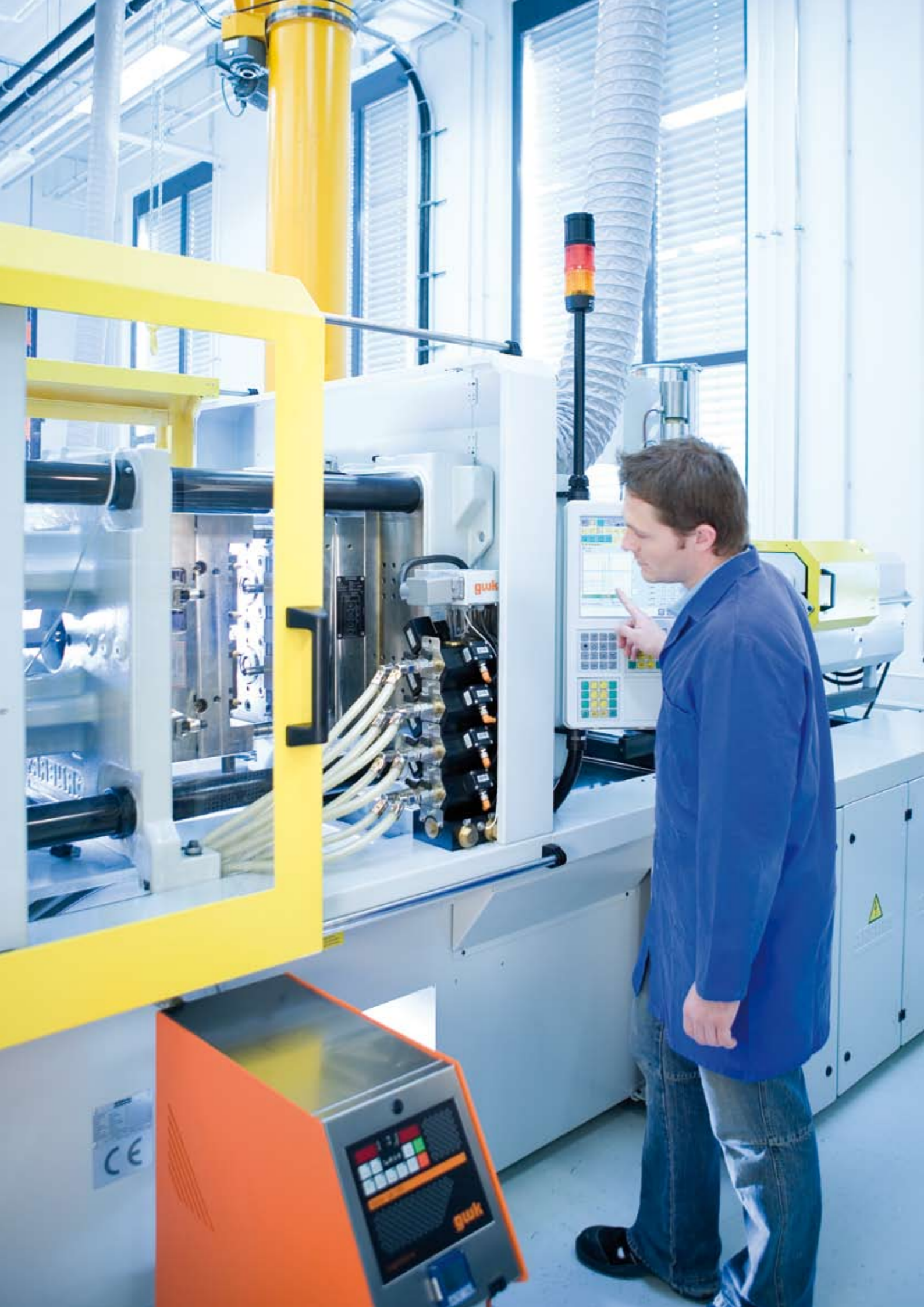

Cooling Efficiency is Top Priority.

Your production lines rely on speed, and whether you produce 200 parts per day or 200,000 pieces per hour, our unique solutions can help you exceed your targets. As up to seventy percent of the injection molding cycle time is attributed to cool down, it is important to focus on the reduction of this potential for improved efficiency.

Today's lean production environment demands superior system performance and networkability. Modular connectivity, decentralized monitoring, intelligence and diagnostics constitute the basis for cooling systems.

Simple traditional on-off control is no longer enough if you want to provide your clients with their desired quality. We understand your challenges; by working together, we can overcome the hurdles towards greater productivity.

Proven reliability, superior accuracy and virtually maintenance-free service ensure Bürkert's systems deliver an unsurpassed total performance every time.

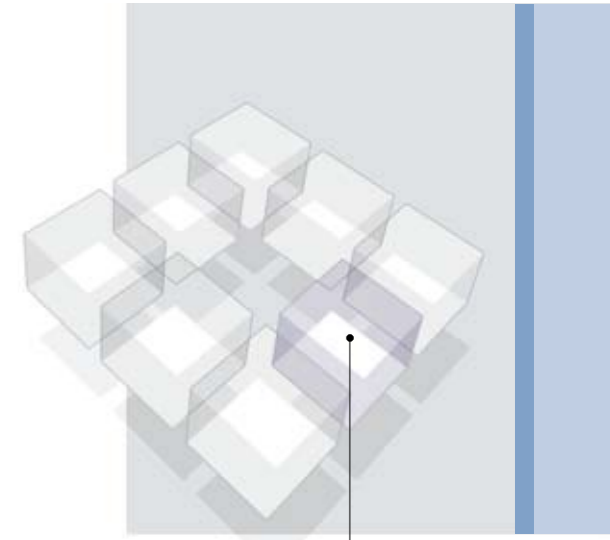

Equipment speed is temperature response dependent.

Process effectiveness is directly proportional to temperature control.



8611 flow controller eCONTROL with cascaded flow input



2835/8012 w/RTD multiport distribution cooling system



8012 reliable quick response blind flow sensor



EXPERIENCE

There are things which are not inherently yours. You have to gather them bit by bit, you receive them from others, and you constantly have to acquire them anew. That is what makes them so valuable. Experience is one of those things. For instance, because of our many years of experience with cooling systems and workflow, we can provide our extensive services to you—from consulting, development, and installation to testing and after-sales service. Be it with individual product solutions or a pioneering new system for the entire measurement and control process: Benefit from our experience!

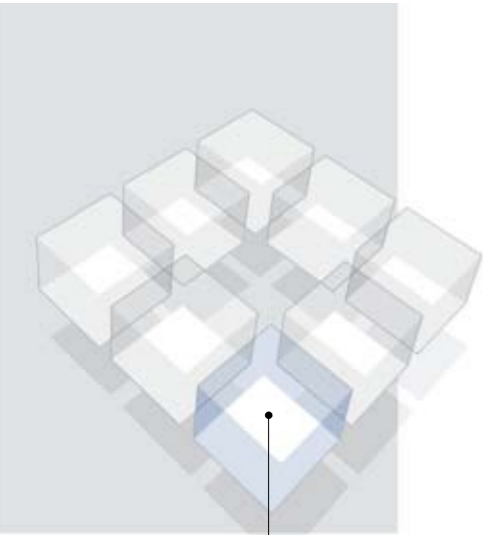

*Cooling rate
and part quality
are related.*

Metallurgical Masterpieces.

Our system solutions have proven themselves with superior cycle life, accuracy and repeatability in plants around the world.

Our experienced support staff is ready and willing. Whether your goal is cost-driven innovation for a new machine, getting more efficiency out of your dies or delivering a great experience to your valued customers, we are here to help.

Our solutions for air or water-cooling are based on a deep understanding of your client's desire for precise metallurgical control. Our patented designs provide more repeatable crystalline structure, higher process efficiencies and higher yields by eliminating stress and porosity.

In the die casting world, we speak your language.

Cooling rate and quality go hand in hand.



2012C + 8030HT high temperature cooling manifold



2012C rugged control valve for cooling applications



8030HT high temperature flow sensor





Quench Your Thirst for Quality.

Improve the flexibility of your induction process by partnering with Bürkert. We have experience in cooling the whole process including copper inductors, quench water and even the high frequency power supply.

Your focus is to maintain tight control of the heating pattern to gain localized surface hardening for wear-resistance. Our job is to work in the high EMF environment, to tackle your often contaminated heat transfer media and to provide cooling process control and valuable process data. Together we can realize a real long-term quality advantage.

Our knowledgeable local engineering teams can take your process layout ideas and help you turn them into reality to save you space and provide reliability and peace of mind.

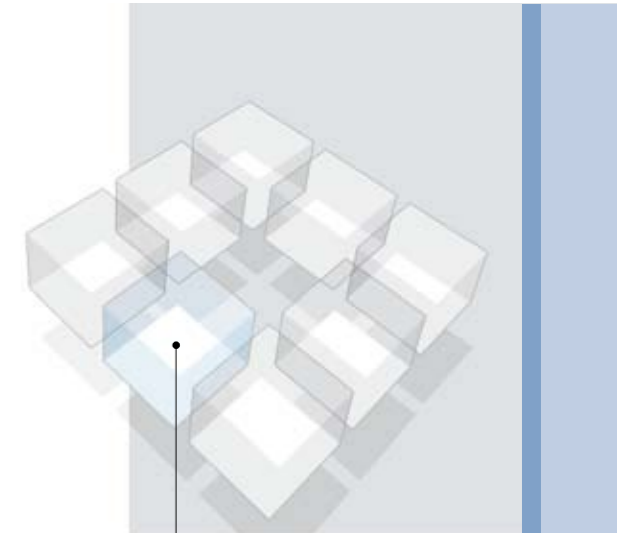

Heat treatment is essential for material behavior.

Tough where required, flexible where needed. This applies to your product and our control systems.



8611 cooling controller and 8810 pneumatic positioning manifold



8039 optical flow sensor



256/6013/6104 multifunction cooling block

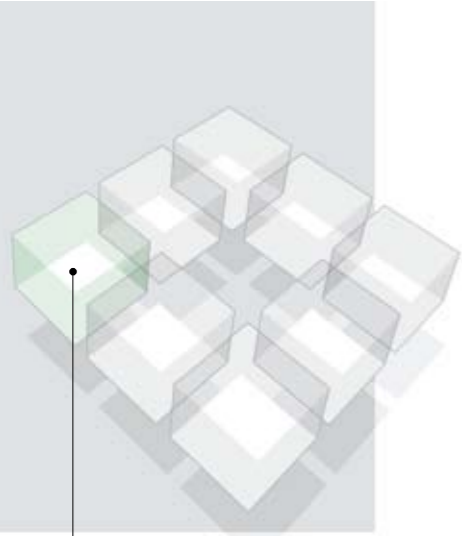

Welding is getting connected.

Protect Your Investments.

Through constant innovation, our cooling technology is designed to "plug and work" in your world.

Experience and knowledge transmitted over many years, means our systems are deployed globally in many fast paced industries. Speed in lean manufacturing environments depends on having the right cooling partner who is committed to the elimination of waste and costly downtime.

Bürkert's clients demand rugged, decentralized monitoring and control to protect their welding equipment investments. Our unlimited modularity means that all of our clients receive a tailor-made fluid control system according to their real life application environment.

Protection of weld head produces endless hours of faultless production.



2030/8039/6014 welding combination cooling manifold system



2-channel monitoring of coolant flow



6128/8012/0282 combination cooling manifold





COURAGE

Those who only work toward optimizing things that already exist will eventually reach the limits—technically, financially, or personally. In order to overcome these limits, courage is needed: The courage to be different and trust one's own ideas; the courage to venture into the unknown, searching for new ways to develop products that have never existed before. We have this courage. By pooling and utilizing our competencies across all sectors, you benefit from our cumulative knowledge of cooling systems—whether it is in automotive fabrication or pharmaceutical packaging.

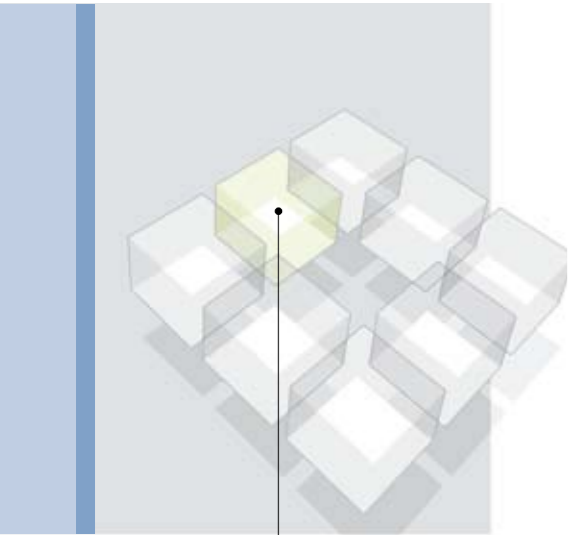

Heat removal keeps you cool in any environment.

Chill... It's Under Control.

Our hardworking valve and sensor elements are compact, smart and easy to commission, making them the perfect choice for heat exchange equipment.

The leading players insist on Bürkert components for both on-off and continuous control loops where we control transfer media from milliliters per hour to cubic meters per minute.

Our experience is backed up by a range of services from valve and flow sensor sizing and commissioning to cooling water chemistry and PID loop tuning.

Our customers stipulate efficiency in communication and ease of ordering and crave convenience and a partner who is fluent in the language of cooling. We are the smart choice.

Exchange your view of ease of installation.



8417 compact RTD with standard DIN connection



8400 control, transmit and display temperature with one device



2712 globe control valve with integrated PID controller



Forming New Ideas.

Thermoforming (vacuum forming, blow molding and blister packing) requires precise control of every cooling loop as it affects the surface appearance, the sealing integrity and the output of the production line.

Through constant innovation, our technology has been designed to work within your environment, meaning each stage of your forming regime can be controlled and safely documented.

Our stable and rugged components are engineered for the harsh production shifts required in an agile manufacturing environment. Our components and systems combine cascade PI control, multi-loop functionality with rugged valves and manifold arrangements.

Our long-term market leadership in solutions engineered for this environment has given rise to a wealth of knowledge and a base for radical cooling innovation.

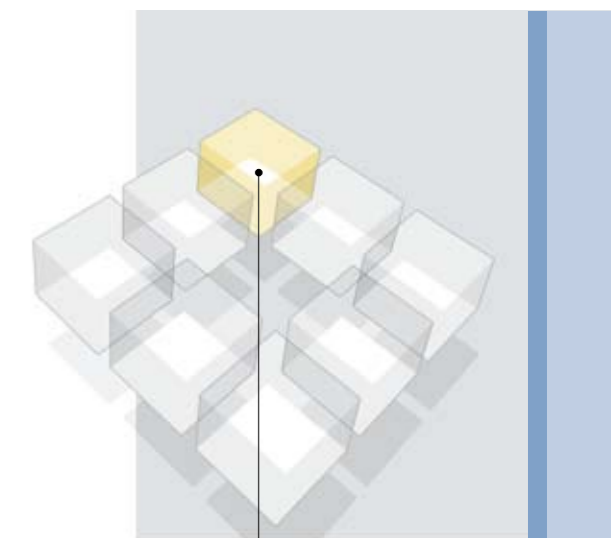

Bürkert provides the solution for any kind of thermoforming process.

Faster, flexible and precise cooling increases production yields.



8611 eCONTROL universal cooling controller



2835 fast, accurate solenoid control valves



8611/S030/2835 multichannel flow control

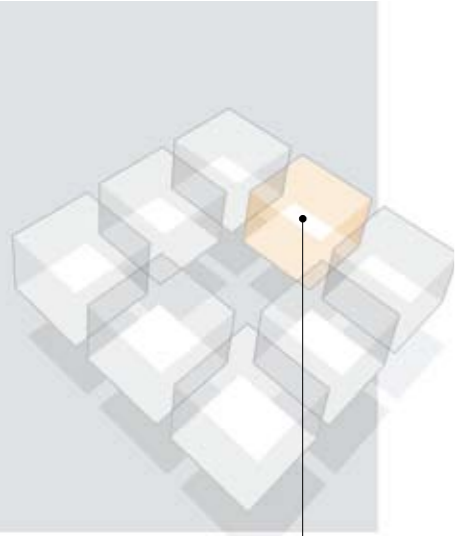

*Fast control keeps
you straight.*

Continuous Perfection.

Your customers trust in your product and quality is synonymous with your brand.

We have helped our clients in numerous industries from making window frames geometrically perfect, to lipstick tubes beautifully flawless regardless of material type or geometry.

Extrusion processes demand precision, reliability, repeatability and flexibility. We can help.

Our multi-channel zone-cooling portfolio provides a basis for custom solutions for air or water extrusion cooling.

Bürkert helps you strengthen your brand.

Keeping a high profile. Straight and consistent.



8323 pressure transmitter



2702/8630 PID enabled control
valve



6027 new, sleek solenoid valves





Time Machine.

Bürkert provides cutting edge cooling solutions for milling, drilling and grinding applications.

Today's production environments demand superior control, monitoring performance and networkability. Bürkert systems provide reliable productivity data from your plant level production network while allowing on-the-fly adjustments of setpoint according to the shape and size of the workpiece.

Whether you cool with water or oil, we have engineered our components to deal with the exact application requirements and have taken the ever present metallic particles into account.

All of the cooling parameters are safe in Bürkert hands, allowing you to machine your product with confidence. Our cool systems specifically eliminate tool damage and save the most important resource ... time.

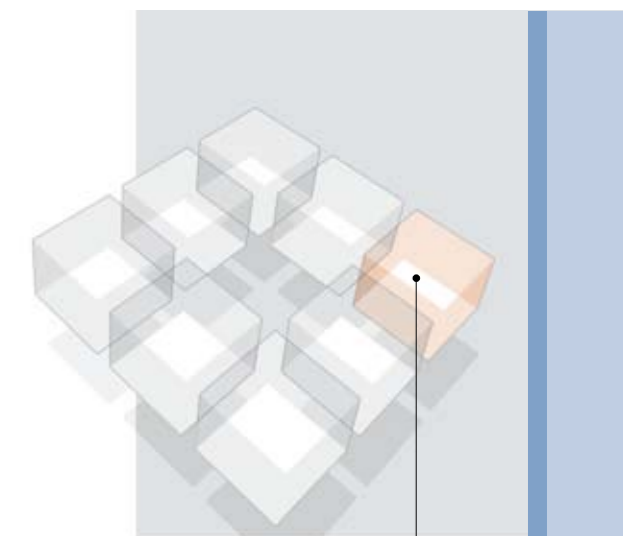

*Milling, drilling, grinding:
For each application the
optimal solution.*

Machining speed and temperature control materials' behavior.



2012C/8611/S030 compact flow-controller



2000 ultrareliable Bürkert angle seat valve



8810 valve positioning system



CLOSENESS

There are things we simply take for granted. Only when they are gone, do we realize how important these things really were. This applies in particular to closeness. Without closeness, it is very difficult to build relationships and a good understanding of one another. As an established medium-sized company, we know that. And that is why we are always there for you. Working with you, we develop the best possible solutions for your projects in the area of cooling systems. Our global presence in 35 locations enables us to press ahead with technical innovations for our customers around the world.

Contacts at Bürkert

North and South America

Brazil

Bürkert-Contromatic Brasil Ltda.
Rua Américo Brasiliense, 2069
Chacara Santo Antônio
04715-005 São Paulo - SP
Brazil
Tel: +55 (0)11-218 611 55
Fax: +55 (0)11-218 611 65
E-mail: pedidos.brasil@burkert.com

Canada

Burkert Contromatic Inc.
5002 South Service Road
Burlington, Ontario L7L 5Y7
Canada
Tel: +1 905-632 30 33
Fax: +1 905-632 38 33
E-mail: sales.ca@burkert.com

USA

Burkert Contromatic Corp.
2602 McGaw Avenue
Irvine, CA 92614
USA
Tel: +1 949-223 31 00
Fax: +1 949-223 31 98
E-mail: marketing-usa@burkert.com

Systemhaus Charlotte

Burkert Contromatic Corp.
2915 Whitehall Park Drive
Charlotte, NC 28273
Tel: +1 704-504-4440
Fax: +1 704-504-3047

Europe

Austria

Bürkert-Contromatic G.m.b.H.
Diefenbachgasse 1-3
AT-1150 Wien
Tel: +43 (0)1-894 13 33
Fax: +43 (0)1-894 13 00
E-mail: info@buerkert.at

Belgium

Bürkert Contromatic NV
Bijkhoevelaan 3
BE-2110 Wijnegem
Tel: +32 (0)3-325 89 00
Fax: +32 (0)3-325 61 61
E-mail: sales.be@burkert.com

Czech Rep.

Bürkert-Contromatic G.m.b.H. organizacni slozka
Krenova 35
CZ-602 00 Brno
Tel: +420 543-25 25 05
Fax: +420 543-25 25 06
E-mail: obchod@burkert.cz

Denmark

Bürkert-Contromatic A/S
Hørkær 24
DK-2730 Herlev
Tel: +45 44-50 75 00
Fax: +45 44-50 75 75
E-mail: info.dk@burkert.com

Estonia

Bürkert Oy Eesti
Laki 11 E
EE-12915 Tallinn
Tel: +372 6440 698
Fax: +372 6313 759
E-mail: info@burkert.ee

Finland

Bürkert Oy
Atomitie 5
FI-00370 Helsinki
Tel: +358 (0)207 412 550
Fax: +358 (0)207 412 555
E-mail: sales.fi@burkert.com

France

BURKERT CONTROMATIC SAS
Rue du Giessen
FR-67220 Triembach au Val
Tel: +33 (0)388-58 91 11
Fax: +33 (0)388-57 20 08
E-mail: burkert.france@buerkert.com

Germany

Bürkert GmbH & Co. KG
Christian-Bürkert-Straße 13 - 17
DE-74653 Ingelfingen
Tel: +49 (0)7940-10-111
Fax: +49 (0)7940-10-448
E-mail: info@de.buerkert.com

Italy

Bürkert Contromatic Italiana S.p.A.
Centro Direzionale „Colombirolo“
Via Roma, 74
IT-20060 Cassina De' Pecchi (Mi)
Tel: +39 02-959 071
Fax: +39 02-959 07 251
E-mail: info@buerkert.it

Norway

Bürkert-Contromatic A/S
Hvamstubben 17
NO-2013 Skjetten
Tel: +47 63-84 44 10
Fax: +47 63-84 44 55
E-mail: buerkert@online.no

Netherlands

Bürkert Contromatic BV
Computerweg 9
NL-3542 DP Utrecht
Tel: +31 (0)346-58 10 10
Fax: +31 (0)346-56 37 17
E-mail: info@burkert.nl

Portugal

Tel: +351 212 898 275
Fax: +351 212 898 276
E-mail: portugal@burkert.com

Poland

Burkert-Contromatic GmbH Oddzial w Polsce
Bernardynska street 14 a
PL-02-904 Warszawa
Tel: +48 (0)22-840 60 10
Fax: +48 (0)22-840 60 11
E-mail: buerkert@buerkert.pl

Spain

Bürkert Contromatic S.A.
Avda. Barcelona, 40
ES-08970 Sant Joan Despi, Barcelona
Tel: +34 93-477 79 80
Fax: +34 93-477 79 81
E-mail: spain@burkert.com

Sweden

Bürkert-Contromatic AB
Skeppsbron 13 B
SE-211 20 Malmö
Tel: +46 (0)40-664 51 00
Fax: +46 (0)40-664 51 01
E-mail: info.se@burkert.com

Switzerland

Bürkert-Contromatic AG Schweiz
Bösch 71
CH-6331 Hünenberg ZG
Tel: +41 (0)41-785 66 66
Fax: +41 (0)41-785 66 33
E-mail: info.ch@buerkert.com

Turkey

Burkert Contromatic Akiskan Kontrol Sistemleri Ticaret A.S.
1203/8 Sok. No2-E
TR-Yenisehir, Izmir
Tel: +90 (0)232-459 53 95
Fax: +90 (0)232-459 76 94
E-mail: burkert@superonline.com

United Kingdom

Burkert Contromatic Limited
Brimscombe Port Business Park
Brimscombe, Stroud
Glos, GL5 2QQ / UNITED KINGDOM
Tel: +44 (0)1453-73 13 53
Fax: +44 (0)1453-73 13 43
E-mail: sales.uk@burkert.com

Africa

South Africa

Bürkert Contromatic (Proprietary) Limited
233 Albert Amon Road
Millennium Business Park
Meadowdale,
Germiston
SOUTH AFRICA
Tel: +27 (0)11-574 60 00
Fax: +27 (0)11-454 14 77
E-mail: sales.za@burkert.com

Asia Pacific

Australia

BURKERT CONTROMATIC AUSTRALIA PTY. LIMITED
15 Columbia Way, Norwest Business Park
Baulkham Hills, NSW 2153, Australia
Tel: +61 2 8853 6353
Fax: +61 2 8853 6363
E-mail: sales.au@burkert.com

Brisbane

BURKERT CONTROMATIC AUSTRALIA PTY. LIMITED
Unit 4/43 Sandgate Road
Albion Queensland 4010
Tel: +61 733 269 640
Fax: +61 733 269 621

Melbourne

BURKERT CONTROMATIC AUSTRALIA PTY. LIMITED
Unit 11/26-30 Howleys Road
Notting Hill Victoria 3168
Tel: +61 385 459 700
Fax: +61 395 626 599

Perth

BURKERT CONTROMATIC AUSTRALIA PTY. LIMITED
104 Westpoint, 396 Scarborough Beach Road
Osborne Park Western Australia 6017
Tel: +61 894 443 980
Fax: +61 892 434 022

China

Burkert Contromatic (Shanghai), Co., Ltd.
Room J1, 3rd floor
207 Tai Gu Road
Wai Gao Qiao Free Trade Zone
Shanghai 200131, China
Tel: +86 21-5868 21 19
Fax: +86 21-5868 21 20
E-mail: info.chn@burkert.com

Beijing

Burkert Contromatic (Shanghai), Co., Ltd.
Room A 1708, Luowa Building, No.203
Er Qu Lizezhongyuan, Wangjing,
Chaoyang District
Beijing 100102, China,
Tel: +86 10 64399783, 64399793
Fax: +86 10 64399612

Chengdu

Burkert Contromatic (Shanghai), Co., Ltd.
Room 603-604, Fuji Building
26 Dongfeng Road, Shudu Dadao
Chengdu China, 610061
Tel: +86 28 8443 9064
Fax: +86 28 8445 1341

Guangzhou

Burkert Contromatic (Shanghai), Co., Ltd.
Room 1502, Tower 4, Dong Jun Plaza
828 - 836 Dong Feng Road East
Guangzhou China, 510080
Tel: +86 20 8769 8379, 8767 8703
Fax: +86 20 87671131

Shanghai

Burkert Contromatic (Shanghai), Co., Ltd.
Room 501/502 Xin Gai Nian Mansion
No.39 Wu Zhong Road
Shanghai China, 200233
Tel: +86 21 6486 5110
Fax: +86 21 6487 4815

Suzhou

Burkert Contromatic (Suzhou), Co., Ltd.
Unit A5, Suhong Square
No.81 Suhong West Road
SIP Suzhou China, 215021
Tel: +86 512 6265 9881
Fax: +86 512 6265 9882

Hong Kong

Burkert Contromatic (China/HK) Limited
Unit K, 9/Floor, Kwai Shun Industrial Centre
No. 51-63 Container Port Road
Kwai Chung, N.T., HONG KONG
Tel: +852 248 012 02
Fax: +852 241 819 45
E-mail: info.hkg@burkert.com

India

Burkert Contromatic PVT Ltd
Apex Towers, 1st Floor, No. 54 II Main Rd
RA Puram
Chennai 600 028, India
Tel: +91 (0)44-4230 3456
Fax: +91 (0)44-4230 3232
E-mail: sales.in@burkert.com

Japan

Burkert Ltd.
Imasu moto asakusa-building
4-9-14 Moto Asakusa, Taito-ku
Tokyo 111-0041, Japan
Tel: +81 (0)3-5827-0066
Fax: +81 (0)3-5827-0067
E-mail: info.jpn@burkert.com

Osaka

Burkert Ltd.
2-8-8-1103 Higashi Nakajima, Yodogawa-ku
Osaka 533-0033, JAPAN
Tel: +81 (0)6-6320-0880
Fax: +81 (0)6-6320-0881

Korea

Burkert Contromatic Korea Co., Ltd.
C-401, Micro Office Bldg. 554-2
Gasam-Dong, Keumcheon-Gu
Seoul 153-803, Korea
Tel: +82 (0)2-3462 5592
Fax: +82 (0)2-3462 5594
E-mail: info.kor@burkert.com

Malaysia

BURKERT CONTROMATIC SINGAPORE PTE LTD
2F-1, Tingkat Kenari 6
Sungai Ara
11960 Penang, Malaysia
Tel: +60 (0)4-643 5008
Fax: +60 (0)4-643 7010
E-mail: info.sin@burkert.com

New Zealand

BURKERT CONTROMATIC NEW ZEALAND LIMITED
44 Rennie Drive
Airport Oaks, Auckland 2022
New Zealand
Tel: +64 (0)9-256 77 37
Fax: +64 (0)9-256 77 47
E-mail: sales.nz@burkert.com

Philippines

BURKERT CONTROMATIC PHILIPPINES, INC.
Nassons Mercantile Building
8467, West Service Road Km 14
South Superhighway, Sunvalley
1700 Paranaque City, Philipines
Tel: +63 (0)2-776 43 84
Fax: +63 (0)2-776 43 82
E-mail: info.rp@burkert.com

Singapore

BURKERT CONTROMATIC SINGAPORE PTE LTD
51 Ubi Avenue 1, #03-14
Paya Ubi Industrial Park
Singapore 408933, Singapore
Tel: +65 6844 2233
Fax: +65 6844 3532
E-mail: info.sin@burkert.com

Taiwan

Burkert Contromatic Taiwan Ltd.
9 F, No. 32, Chenggong Road, Sec. 1,
Nangang District
TAIPEI
Taiwan 115, R.O.C.
Tel: +886 (0)2-2653 7868
Fax: +886 (0)2-2653 7968
E-mail: info.rc@burkert.com

Credits:

© Christian Bürkert GmbH & Co. KG
Concept and realization:
wolf media lounge, Berlin
Photography: Studio Flamisch, Düsseldorf;
Münch & Schmidt, Stuttgart;
All people shown in the brochure are employees at Bürkert.
Thank you very much for your support (and spirit).